

TOP VIEW
SCALE 1 : 25

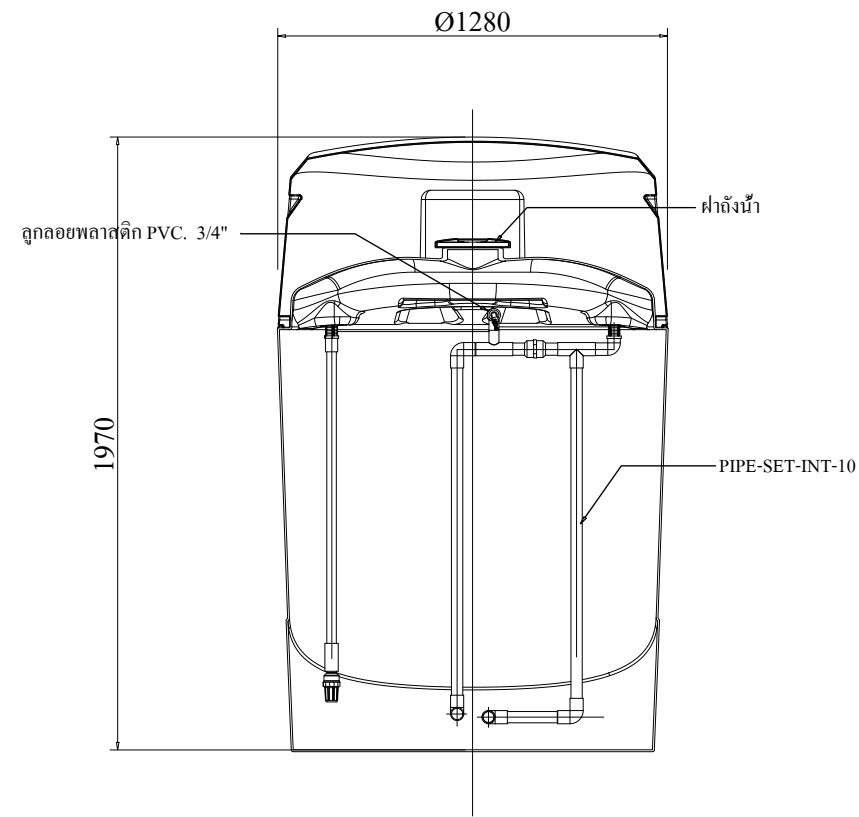

SECTION A-A
SCALE 1 : 25

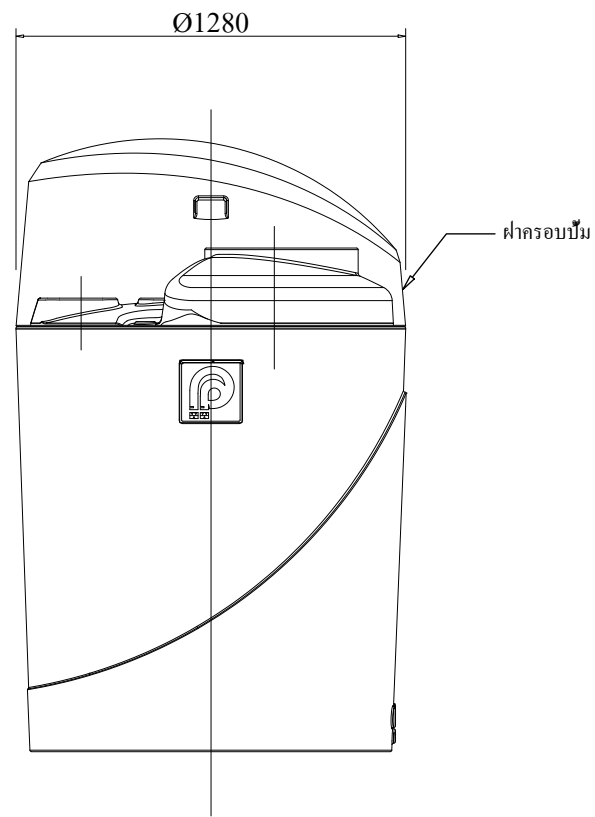

SECTION B-B
SCALE 1 : 25

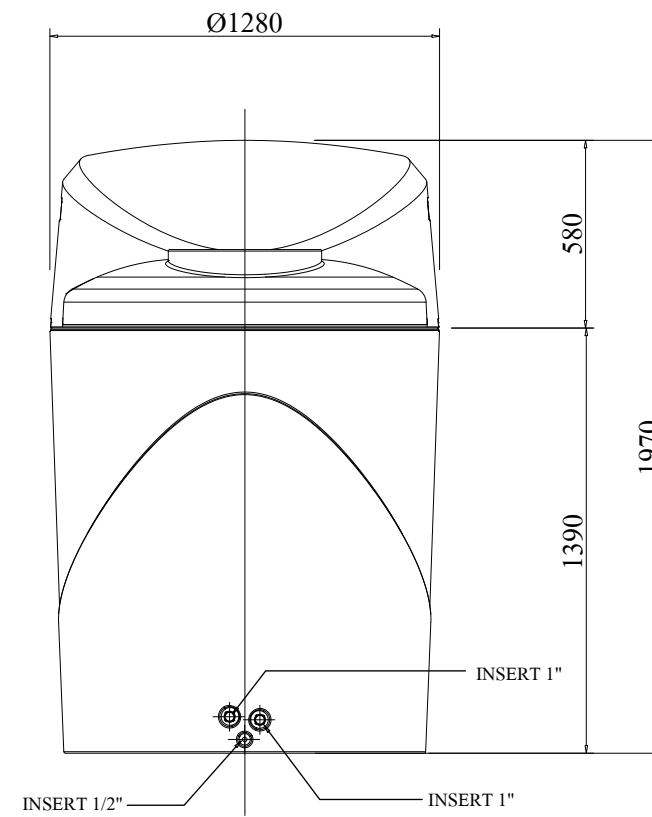

LEFT VIEW
SCALE 1 : 25

CONSULTING ENGINEER

PROJECT TITLE

OWNER ADDRESS

SIGNATURE

MODEL SMARTPAK PRO-1500

DRAWING TITLE

SCALE 1 : 25

SHEET No./TOTAL

DRAWING CODE

SMARTPAK PRO-1500.dwg

ENGINEER

DESIGNED

DRAWN S.SAHARAT

21/11/2022

APPROVED U. PHICHAYASAK

PRODUCT NAME



PREMIER PRODUCTS PUBLIC COMPANY LIMITED.

OFFICE : 2 Premier Place, Soi Premier 2, Srinakarin Rd., Nongbon, Prawet, Bangkok 10250, Thailand
Tel : 02301-2100-1 Fax : 0-2301-2141

FACTORY: 454 Moo 9 Kabinburi Industrial Zone, Km 12 Kabinburi-Korat-Highway Tombon Nonggee Umper Kabinburi 25110 Thailand
Tel : (037) 204396-406 Fax : (037) 204407

DRAWING HISTORY